

ELEVAH[®] 80 Move Picking FL

- **Tool max. working height: 6,6 m**
- **Standard:** Tyres storage system with single adjustment (stroke). **Optional:** double adjustment (stroke/slope)
- **Tool max. capacity: 150 kg**
- Width of the short side: 78 cm
- Side tool rollers with adjustable height and adjustable width to make storage operations easier.
- Turning radius = 0
- Self propelled when raised at the maximum height

The operator can storage in a few time also complete wheels (rim and tyre) and/or big tires (the max. capacity of the tool is 150 kg).



The forks pick up trolleys of different sizes

ELEVAH® 75 Tires

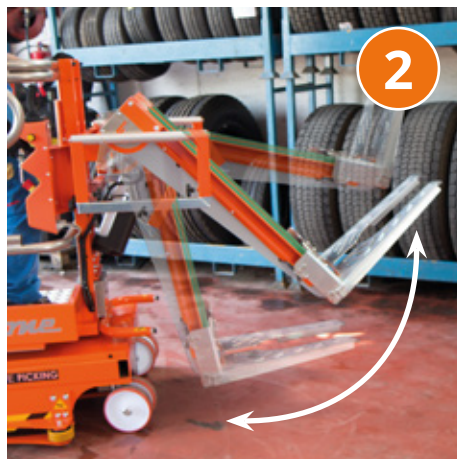
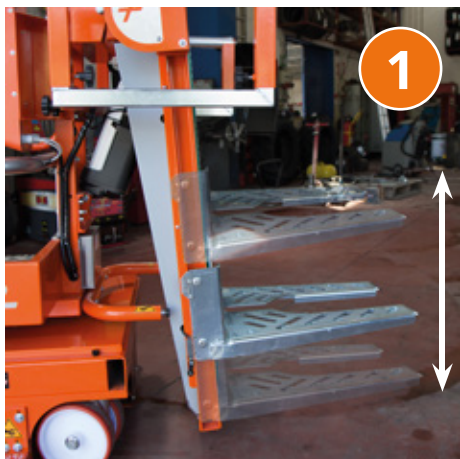

Standard: Tyres storage system with single adjustment (stroke). Optional: double adjustment (stroke/slope)

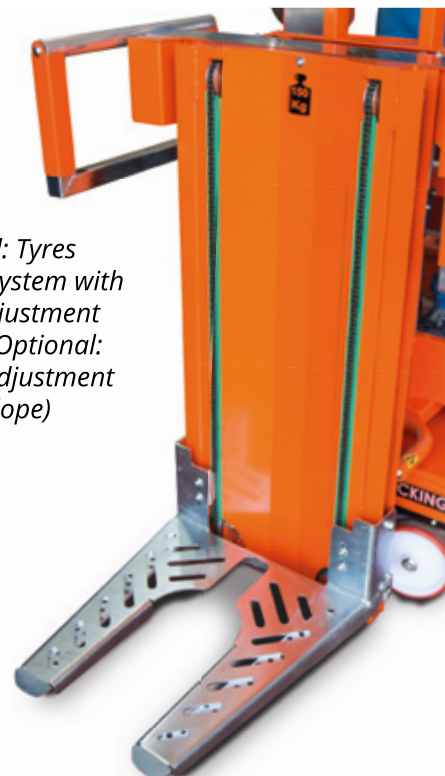

Side tool rollers with adjustable height and adjustable width to make storage operations easier.



OPTIONAL: possibility of adding an arm with lifting ropes for stowing tyres flat. It helps to move the tyres from the tool to the shelf without lifting it. The operator doesn't make any effort and always keeps the correct position

OPTIONAL: Side Roller



ELEVAH[®] 75 Tires

Max. working height	7,60 m	
Max capacity	250 kg	
Number of people	1	
Use	Internal - External	
A	Closed machine height	1960 mm
A1	Machine height with accessory	2755 mm
B	Minimum platform height	455 mm
C1	Max platform height with vertical tyres tool	5610 mm
C2	Max platform height with horizontal tyres tool	5010 mm
C3	Max picking platform height with vertical tyres tool	6330 mm
C4	Max picking platform height with horizontal tyres tool	6160 mm
D	Base overall dimensions	2080 mm
E		780 mm
F	Cage dimensions	730 mm
G		705 mm
Machine weight	1270 kg	
H	Fixed picking tray dimensions	460 mm
I		760 mm
Fixed picking tray capacity	20 kg	
Drive wheels dimension	Ø 230 x 60 mm	
Swivel wheels dimensions	Ø 200 x 50 mm	

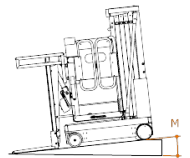
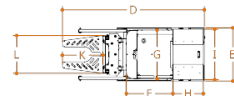
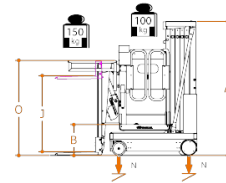

RUBBER TOOL

O	Height	1375 mm
K	Fork size	600 mm
L		555 mm
	Vertical adjustment	Electrical
J	Stroke	1115 mm
	Min. height from the ground	40 mm
	Maximum height from the ground	5200 mm
	Rotation	Electrical
	Max. rotation angle	90°
	Maximum height from the ground (rotated)	6160 mm
	Capacity	150 kg

PERFORMANCE

	Power supply	24 V
	Batteries	Lead-Acid Batteries 12V 105 Ah
	Battery charger	110V – 220V
M	Maximum climbing ability	15%
	Climbing ability at height	2,5%
	Internal turning radius	0
	External turning radius	1025 mm
	Max. speed (rising – descending)	0,2 m/s
	Maximum translation speed	5 km/h
	Maximum translation speed at height	1 km/h
N	Maximum pressure for wheel at full load*	5,2 kN
	Work cycles (with fresh batteries) **	130

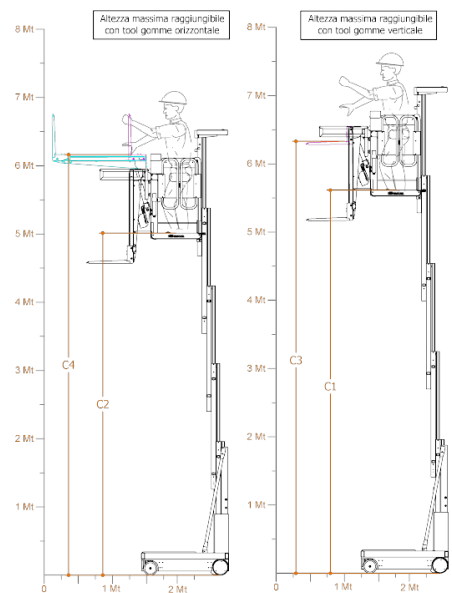

* Maximum pressure whereas the weight of the platform plus the maximum load on the basket are completely distributed on one side of the platform (totally asymmetric load).

** By work cycle we mean a self-propelled movement of 20 m with a full ascent to and descent from the maximum height and with adjustment of the loading platform.



Complies with European regulations for man-up forklift trucks. UNI EN ISO 3691-1.